

A	B	C	D
1	S455-3001	1370	220
2	S455-4001	1430	165

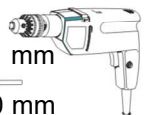

Ø 6 mm

Ø 10 mm

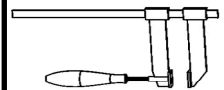
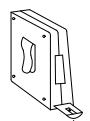
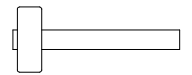
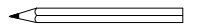
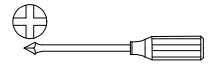
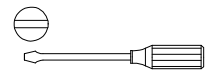
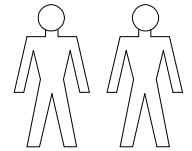
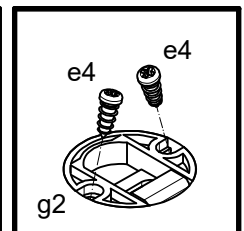
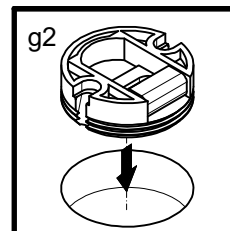
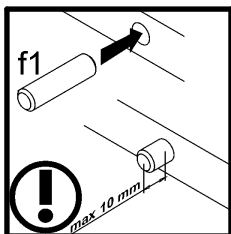
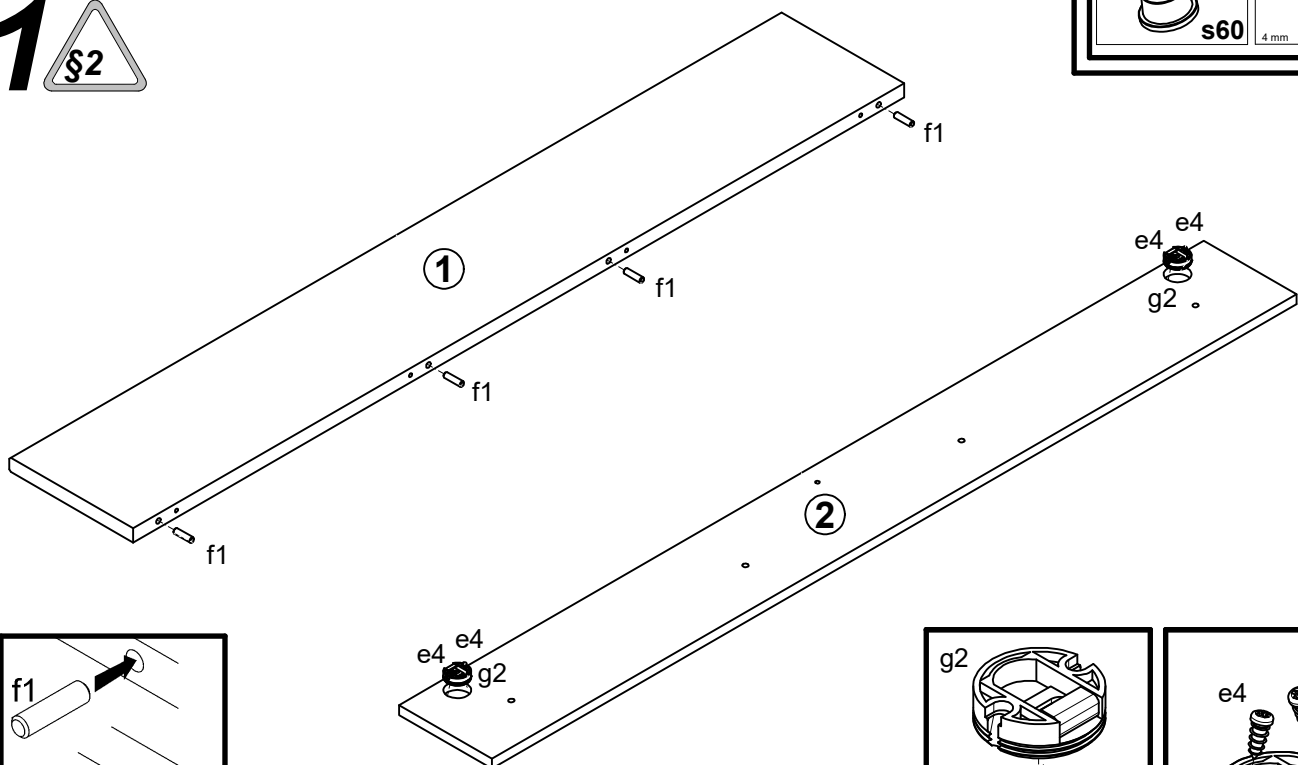
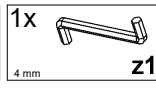
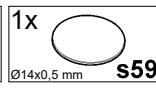
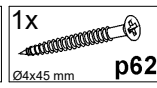
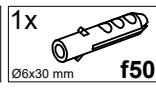
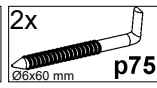
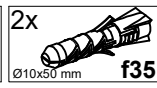
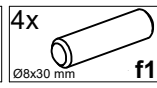
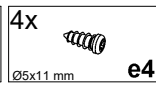
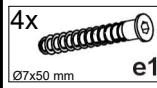
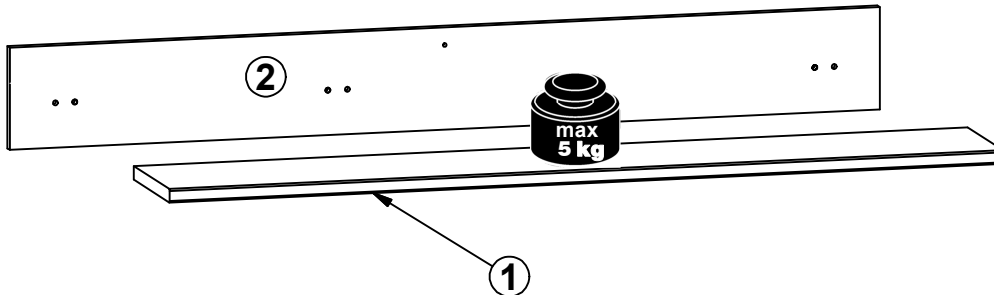
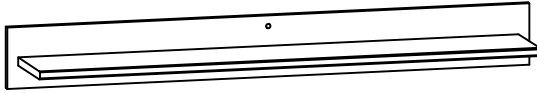

2

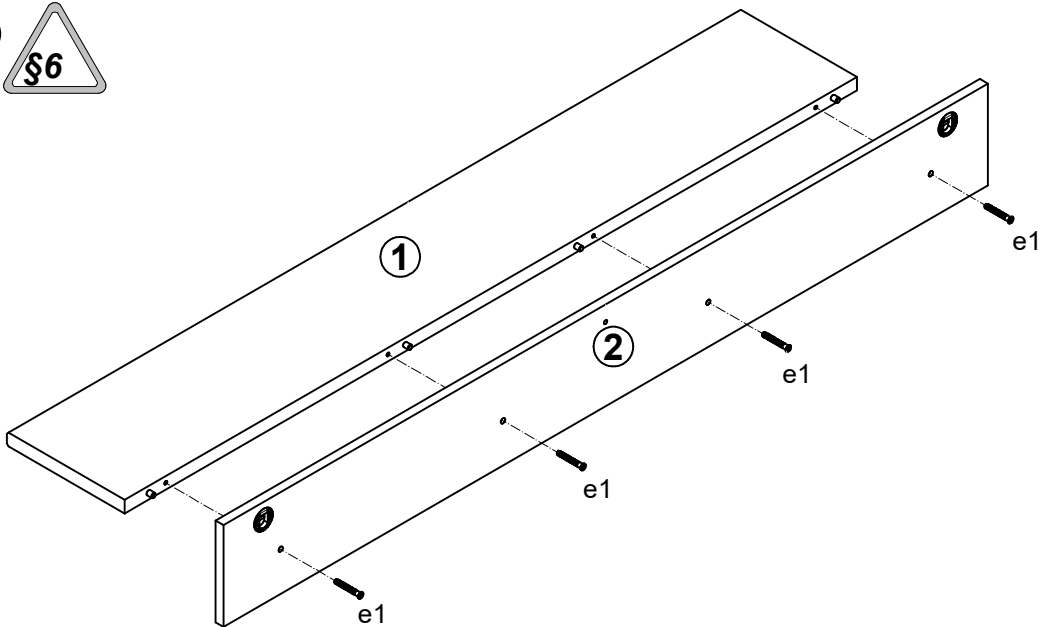

3

